



## Play Snoot Round Adjustable

LedsC4 Team

Downlight Play Snoot Round Adjustable 8 34.5° White IP54 317lm

### Technical features

Luminaire total power: 8W

Lens / reflector angle: MEDIUM 35°

Structure material: Aluminium

Structure finish: White

Recommended light bulb: GU10

Voltage / frequency: 100-240V/50-60Hz

Warranty: 5 years

Easily recyclable luminaire



### Luminotechnic features

Lampholder	Quantity	Light source power (W)	Correlated Colour Temperature (CCT)
GU10	1	Max. power 8W	-

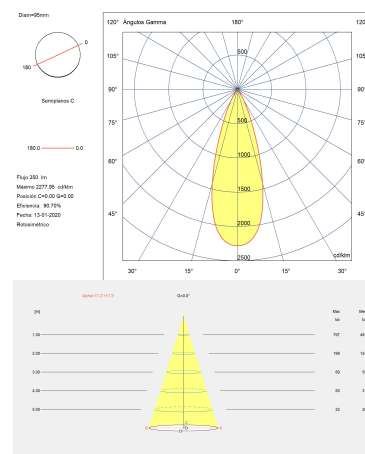
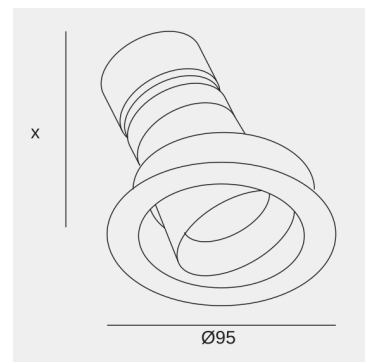
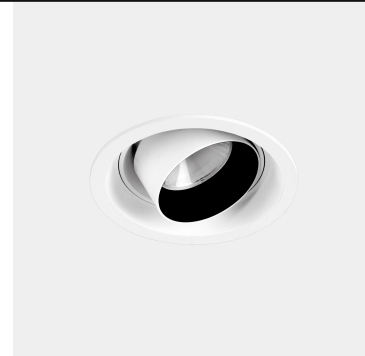

Image may not match reference. LedsC4 reserves the right to amend any of the product's components. The data related to flux, power and colour temperature may be subject to changes made by the manufacturer.



## Play Snoot Round Adjustable

LedsC4 Team

Downlight Play Snoot Round Adjustable 8 34.5° White IP54 317lm

### Logistics

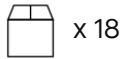

Net weight (kg): 0.16

Packaged weight (kg): 0.27

Packaging: 170mm x 120mm x 120mm

Image may not match reference. LedsC4 reserves the right to amend any of the product's components. The data related to flux, power and colour temperature may be subject to changes made by the manufacturer.



## Play Snoot Round Adjustable

LedsC4 Team

Downlight Play Snoot Round Adjustable 8 34.5° White IP54 317lm

### Optional accessories



71-4754-14-00

White visual comfort

Structure material: Polycarbonate  
Dimensions: 52 x NA x 27  
Net weight (kg): 0.01



71-4754-60-00

Black visual comfort

Structure material: Polycarbonate  
Dimensions: 52 x NA x 27  
Net weight (kg): 0.01

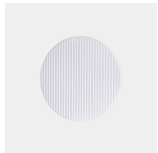

71-5167-00-00

5 x Elliptical diffuser

Structure material: Methacrylate  
Dimensions: 44 x NA x 2  
Net weight (kg): 0.01



71-5658-00-00

5 x Square diffuser

Structure material: Methacrylate  
Dimensions: 44 x NA x 2  
Net weight (kg): 0.08

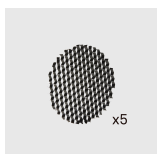

71-5166-60-00

5 x Honeycomb panel

Structure material: Aluminium  
Dimensions: 44 x NA x 2  
Net weight (kg): 0.01

Image may not match reference. LedsC4 reserves the right to amend any of the product's components. The data related to flux, power and colour temperature may be subject to changes made by the manufacturer.

# Optional accessories

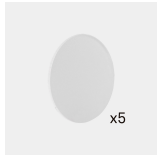

71-6099-00-00

5 x Halo diffuser

Structure material: Methacrylate

Dimensions: 47 x NA x 2

Net weight (kg): 0.01

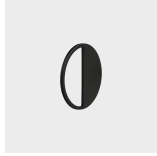

71-7895-60-00

5 x Screen

Structure material: Steel

Dimensions: 46 x NA x 2

Net weight (kg): 0.09



ACT-FLL-024

Structure material: Polycarbonate

Dimensions: 50 x NA x 55

Net weight (kg): 0.05



ACT-FLL-025

Structure material: Polycarbonate

Dimensions: 50 x NA x 55

Net weight (kg): 0.05



ACT-FLL-026

Structure material: Polycarbonate

Dimensions: 50 x NA x 55

Net weight (kg): 0.06



ACT-FLL-027

Structure material: Polycarbonate

Dimensions: 50 x NA x 55

Net weight (kg): 0.06



ACT-FLL-028

Structure material: Polycarbonate

Dimensions: 50 x NA x 55

Net weight (kg): 0.06



ACT-FLL-029

Structure material: Polycarbonate

Dimensions: 50 x NA x 55

Net weight (kg): 0.06

Image may not match reference. LedsC4 reserves the right to amend any of the product's components. The data related to flux, power and colour temperature may be subject to changes made by the manufacturer.